

FY2017/12 Results Briefing (IFRS)

February 19, 2018

Nabtesco Corporation

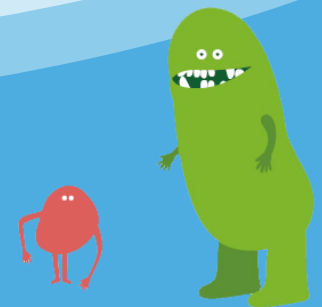
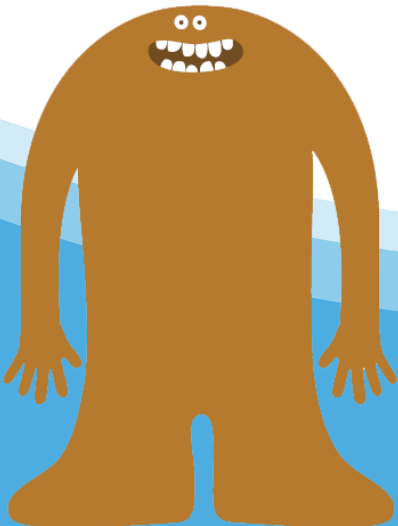

The forecast data presented herein reflects assumed results based on conditions that are subject to change. Nabtesco Corporation does not make representations as to, or warrant, in whole or in part, the attainment or realization of any of the forecasted results presented in this document. Numerical figures presented herein are rounded down.

1. Annual Consolidated Results for FY2017/12

2. Forecast for FY2018/12

3. Progress in Mid-Term Management Plan



1. Annual Consolidated Results for FY2017/12

2. Forecast for FY2018/12

3. Progress in Mid-Term Management Plan

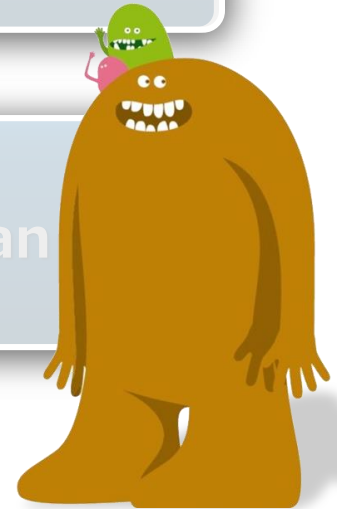

Result for FY2017/12 (IFRS)

- Led by good result of CMP, both sales and profits increased on a year-on-year basis and compared with and the plan (as of Jul. 31, 2017) achieving the highest sales and profits in history.

(JPY million)	2016/12 Result (A)	2017/12 Revised Plan (As of Jul. 31, 2017) (B)	2017/12 Result (C)	Ratio of Variation ((C-A)/A)	Ratio of Variation ((C-B)/B)
Sales	244,968	273,000	282,422	15.3%	3.5%
Core O.P. *2	25,165	28,400	29,155	15.9%	2.7%
(Core OPM)	10.3%	10.4%	10.3%	-	-
O.P.	25,982	28,400	29,468	13.4%	3.8%
(OPM)	10.6%	10.4%	10.4%	-	-
Finance Income and Cost	-237	-	523	-	-
Equity in earnings of affiliates	1,034	-	4,915	-	-
Income before tax	26,779	32,100	34,907	30.4%	8.7%
Net profit *3	18,606	23,900	25,146	35.2%	5.2%

Earnings per share (JPY Yen)	150.64	193.60	203.85
DPS (JPY Yen)	50	68(Plan)	72(Plan)
Payout ratio	33.2%	35.1%	35.3%

*1 CMP : Component Solutions Segment

*2 Core operating profit is net sales less cost of sales and selling, general and administrative expenses.

*3 Net profit attributable to owners of the parent

FY2016/12 Result vs. FY2017/12 Result by Segment

- Both net sales and profits increased reflecting robust demand for precision reduction gears for industrial robots, the recovery of demand for construction machinery in China as well as the effects of converting a sales company of automatic doors into a consolidated subsidiary.

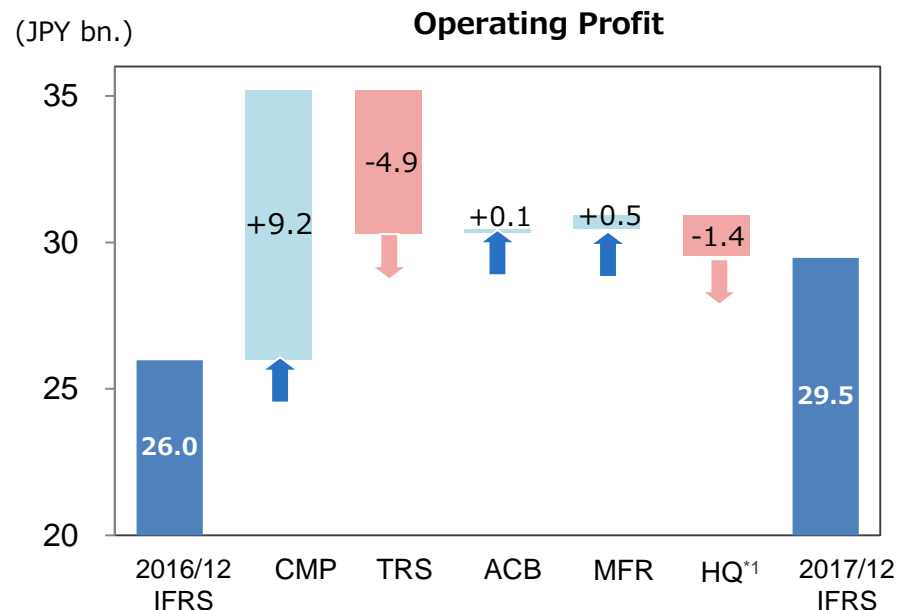
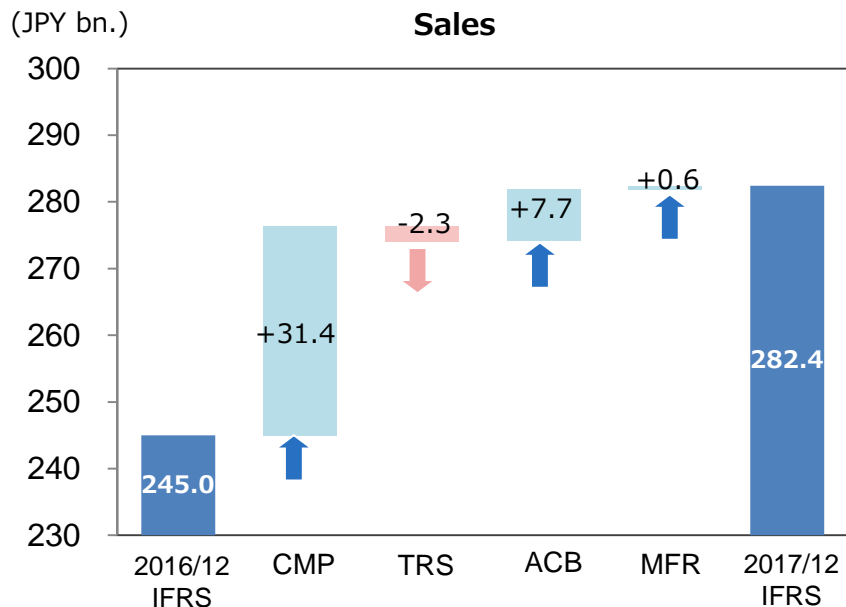

- Component Solutions Segment (CMP)** : Robust performance was recorded in precision reduction gears for industrial robots for automation and labor-saving needs, and for general industry. Sales and profit increased on the back of higher demand for construction machinery in China.
- Transport Solutions Segment (TRS)** : Sales of railroad vehicle equipment decreased high-speed railroad vehicles in China. Aircraft equipment faced a decline in sales in the off-season due to a model change of B777. Marine vessel equipment suffered a decrease in sales due to the sluggish shipbuilding market. Sales of commercial vehicle equipment increased due to robust domestic demand. Overall, this segment saw a decrease in profit.
- Accessibility Solutions Segment (ACB)** : Sales increased reflecting robust domestic demand and the conversion of an acquired company into a consolidated subsidiary (for a quarter), although the growth ratio was limited due to the PMI*2 cost associated with a North American subsidiary.
- Manufacturing Solutions Segment (MFR)** : The packaging machines business recorded an increase in sales reflecting domestic labor-saving needs.

*1 Corporate or Elimination *2 PMI(Post Merger Integration)

Revised Plan(As of Jul. 31, 2017) vs. FY2017/12 Result by Segment

■ The CMP segment was also robust in the second half of the fiscal year, and both sales and profits exceeded the plan.

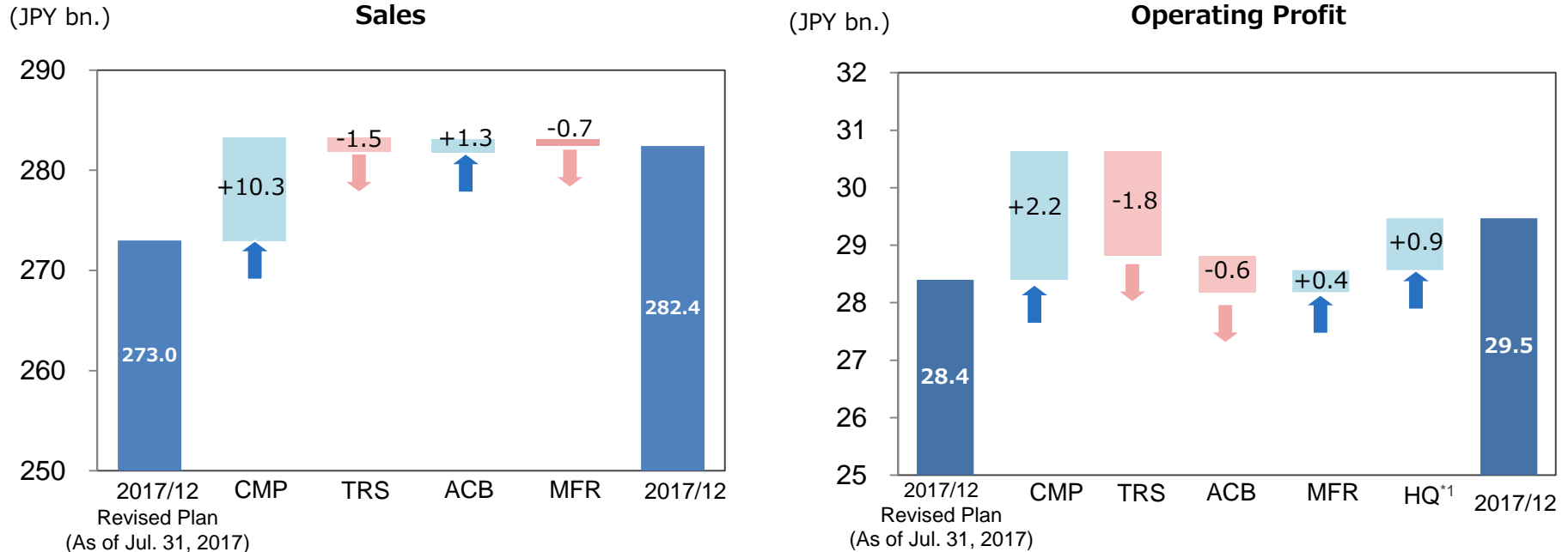

Component Solutions Segment (CMP) : Continued from the first half of the fiscal year, both sales and profit increased reflecting strong demand for precision reduction gears for industrial robots and general industry, and demand for construction machinery in China.

Transport Solutions Segment (TRS) : Sales decreased in both railroad vehicle equipment and aircraft equipment due to a decline in after-sales-services business (MRO *2). Marine vessel equipment remained in line with the plan. Commercial vehicle equipment suffered a decrease in sales due to a delay in sales expansion. In sum, this segment recorded a decrease in profit due to a decline in sales.

Accessibility Solutions Segment (ACB) : Profits decreased due to a delay of PMI*3 of a North American subsidiary despite sales growth reflecting an increase in domestic sales and the impact of favorable currency movements.

Manufacturing Solutions Segment (MFR) : Sales in MRF decreased due to a delay in sales expansion in other subsidiaries despite robust performance. (In the packaging machines business, sales increased reflecting robust demand due to domestic labor-saving needs.) In sum, this segment recorded an increase in profit.

*1 Corporate or Elimination * *2 Maintenance, Repair and Overhaul *3 PMI(Post Merger Integration)

Analysis of Changes in Operating Profit by Company (FY2016/12 Result vs. FY2017/12 Result)

■ Expansion of profits by increasing sales in CMP

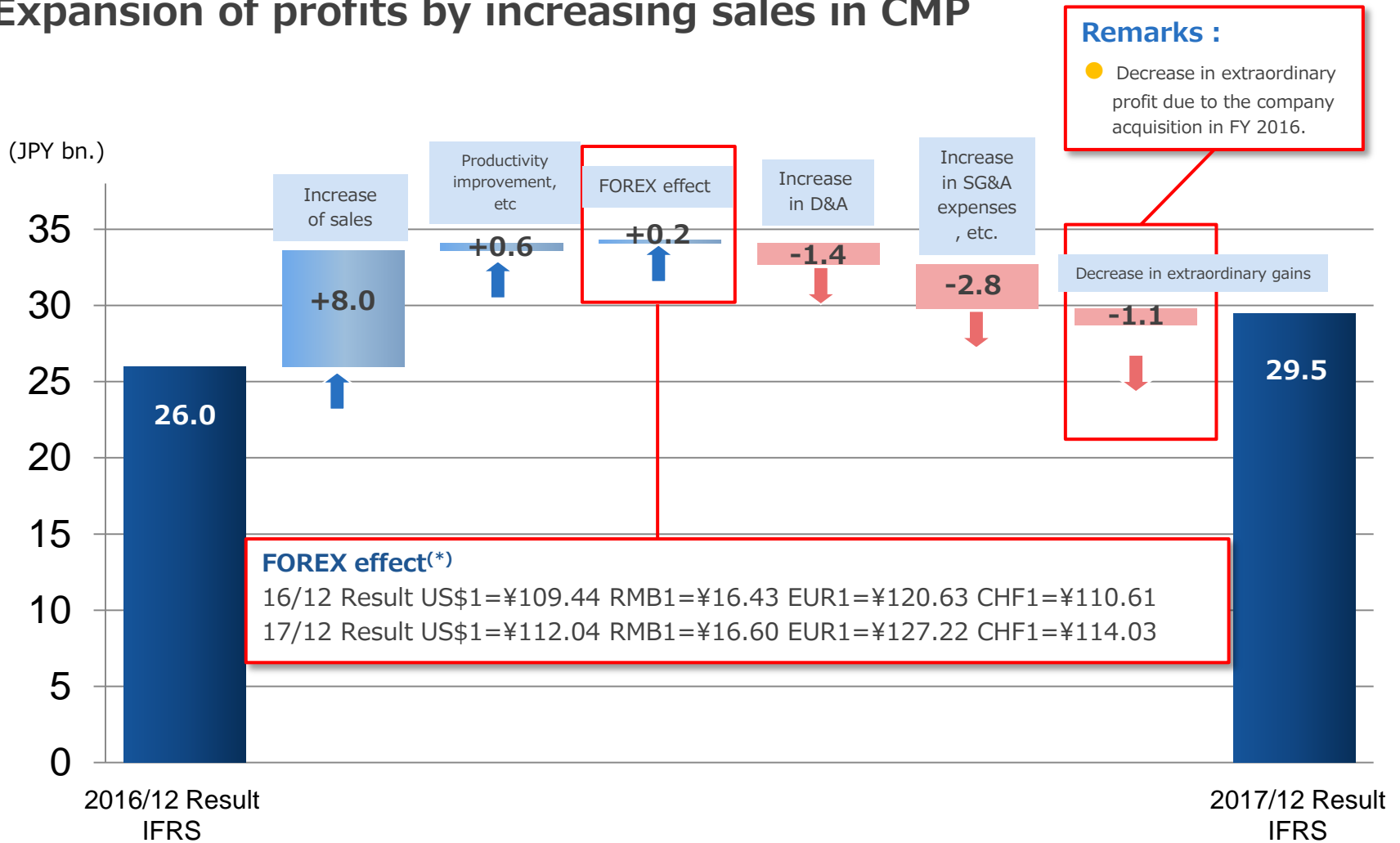

* FOREX sensitivity in O. P. (This represents the effect to be expected on operating profit if the exchange rate fluctuates by one yen):
(US\$): 33 million yen, (RMB) : 267 million yen, (EUR) : minimal, (CHF) : minimal

Balance sheet (2016/12 Result vs. 2017/12 Result)

- Balance sheet remained sound during implementation of steady investments for growth.

(JPY million)	2016/12 (as of December 31, 2016)	2017/12 (as of December 31, 2017)	Variation
Assets	256,973	301,557	44,584
(Cash and cash equivalents)	41,780	44,121	2,341
(Trade receivable)	65,569	76,874	11,305
(Inventories)	32,704	40,298	7,594
(Tangible fixed assets)	63,155	70,700	7,545
Liabilities	101,070	124,556	23,486
(Bonds and borrowings)	16,949	27,720	10,771
Total equities	155,904	177,002	21,098
(Non-controlling interests)	7,974	9,465	1,491
Equity attributable to owners of parent	147,929	167,537	19,607

*Ratio of equity attributable to owners of parent:

57.6%

55.6%

-

1. Annual Consolidated Results for FY2017/12

2. Forecast for FY2018/12

3. Progress in Mid-Term Management Plan

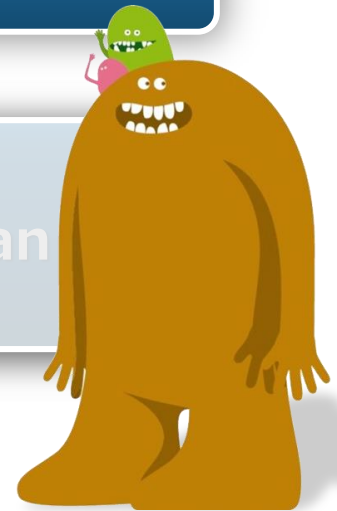

Forecast for FY2018/12 (IFRS)

- Targeting exceeding 10% OPM on the back of a robust performance in the CMP segment are anticipated.

(JPY million)	2017/12 Result (A)	2018/12 Plan (B)	Variation (B-A)	Ratio of Variation ((B-A)/A)
Sales	282,422	308,000	25,578	9.1%
O.P.	29,468	32,600	3,132	10.6%
(OPM)	10.4%	10.6%	0.2pt	-
Income before tax	34,907	35,900	993	2.8%
Net profit *	25,146	25,700	554	2.2%

DPS (JPY Yen)	72(Plan)	73(Plan)
Payout ratio	35.3%	35.0%

Remarks :

- Increase in demand for precision reduction gears for industrial robots and general industry.
- Increase in sales in Hydraulic Equipment business due to expected growth in demand for construction machinery.

Remarks :

- Ratio of variation in net profit is 15% excluding 28 billion yen gained by equity in earnings of affiliates.

* Net profit attributable to owners of the parent

Analysis of Changes in Operating Profit by Company (FY2017/12 Result vs. FY2018/12 Plan)

■ Expansion of profits by increasing sales.

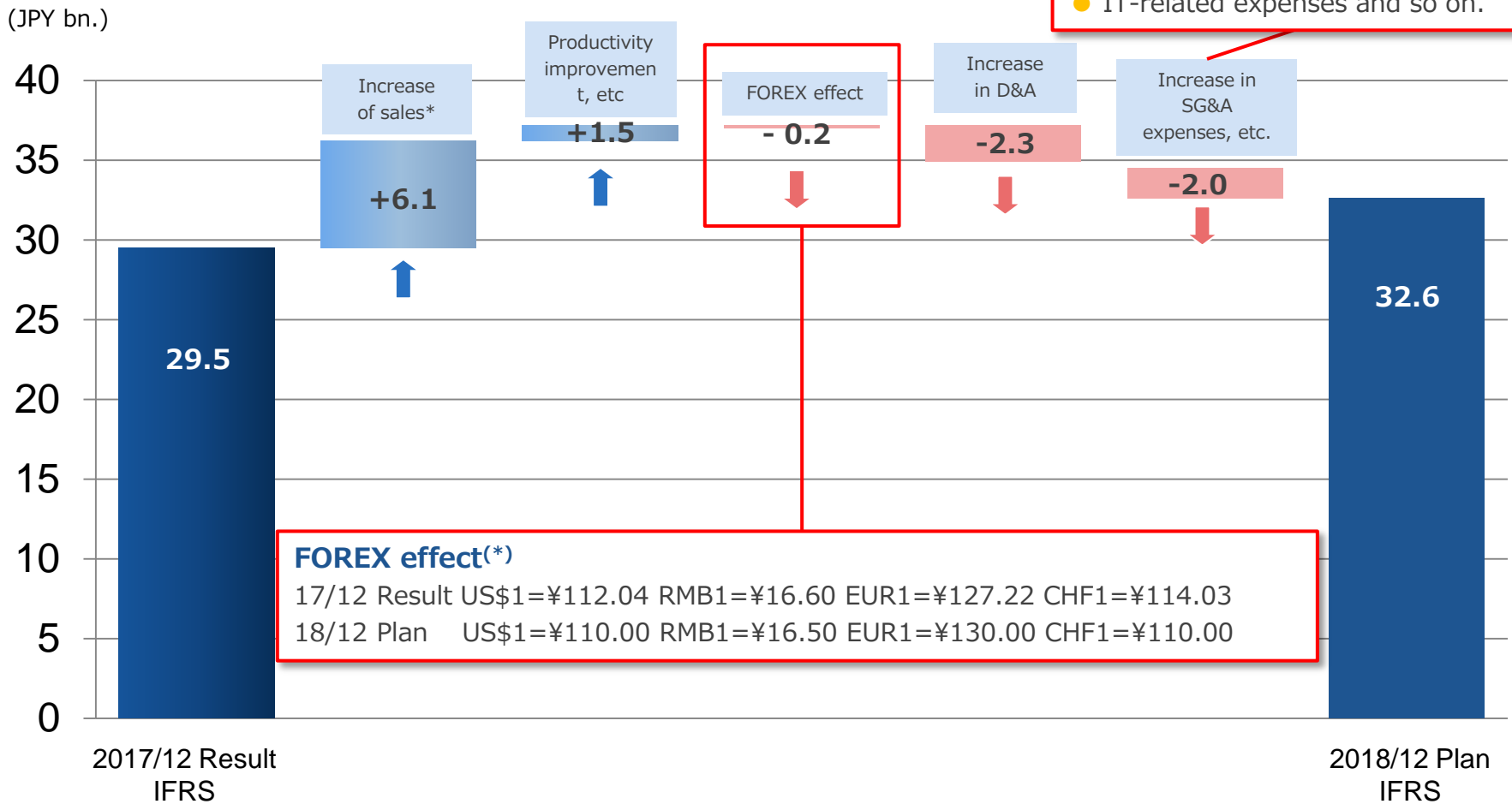

*FOREX sensitivity in O. P. (This represents the effect to be expected on operating profit if the exchange rate fluctuates by one yen):
 (US\$): 40 million yen, (RMB) : 299 million yen, (EUR) : minimal, (CHF) : minimal

Component Solutions Segment (CMP)

- Sales and profit are anticipated to grow reflecting an increase in demand for precision reduction gears for industrial robots and general industry, and global demand for construction machinery.

Result and Plan

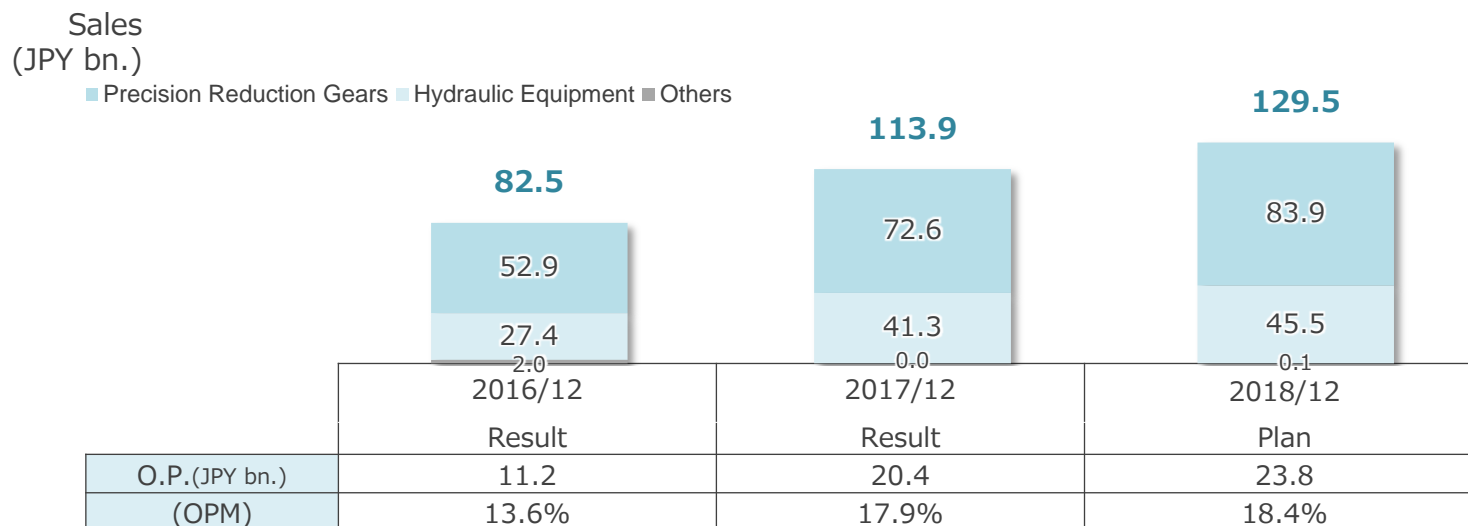

FY2017/12 Result vs. FY2018/12 Plan

Precision Reduction Gears : Sales are expected to grow reflecting an increase in demand for precision reduction gears for industrial robots and general industry on the back of automation and labor-saving demand in the automobile industry and general industry.

Hydraulic Equipment : Sales are anticipated to increase due to expected growth in global demand for construction machinery.

O.P. : Expansion of profits by increasing sales.

Transport Solutions Segment (TRS)

- Sales and profit are anticipated to grow in TRS.

Result and Plan

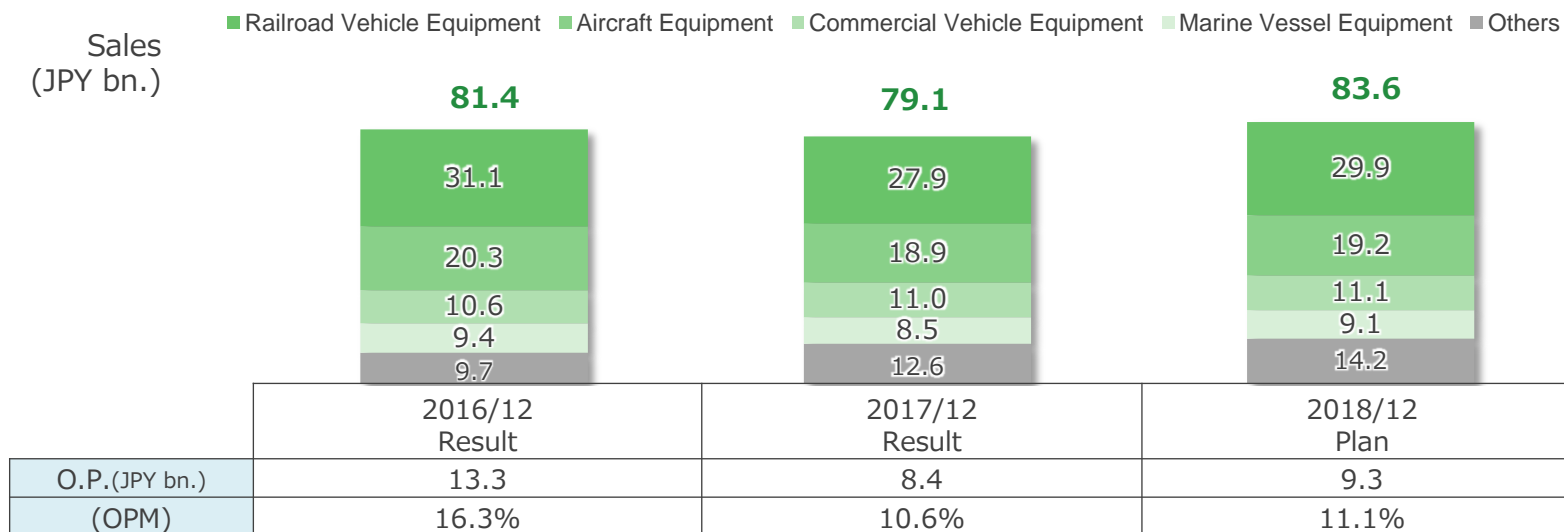

FY2017/12 Result vs. FY2018/12 Plan

Railroad Vehicle Equipment : Sales growth is anticipated through meeting robust domestic demand and expanding order receipts from subway projects in China.

Aircraft Equipment : Expected to remain flat on the back of the continued off-season for aircraft in the civil aviation sector.

Commercial Vehicle Equipment : Expected to remain flat reflecting continued robust demand in Japan and Southeast Asia.

Marine Vessel Equipment : Sales growth is anticipated reflecting the gradual recovery of the marine transport market.

O.P. : An increase is expected driven by sales growth and proactive expansion of MRO.

Accessibility Solution Segment (ACB)

- Sales and profit are anticipated to grow by meeting demand for domestic and overseas building automatic doors.

Result and Plan

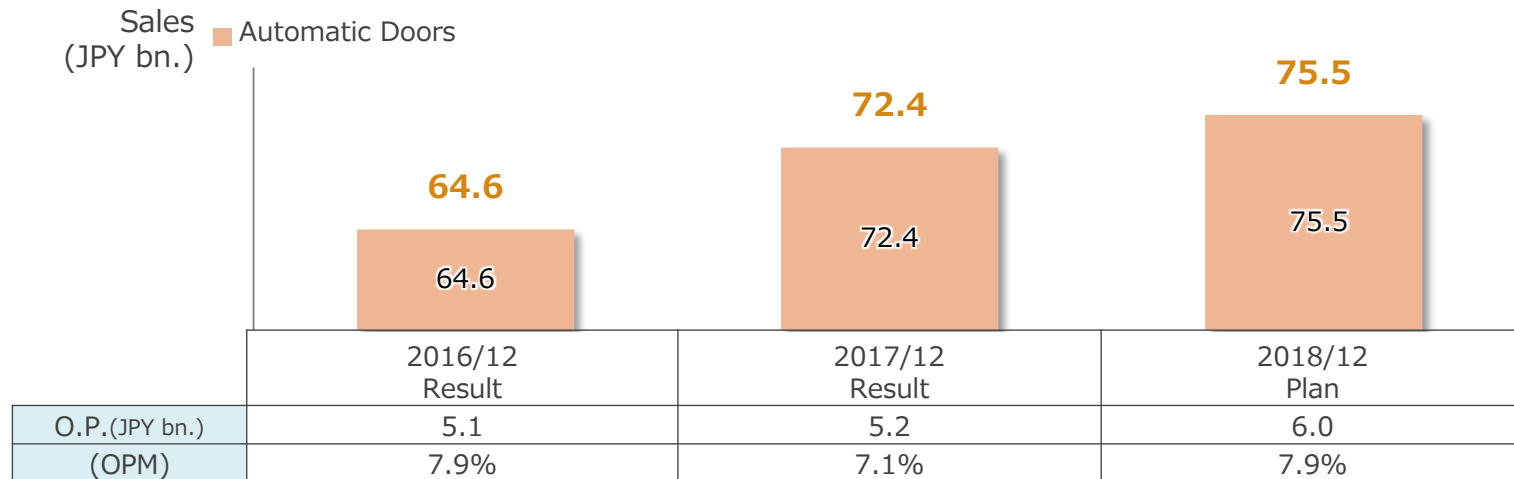

FY2017/12 Result vs. FY2018/12 Plan

Automatic Doors : Sales are anticipated to grow by meeting demand for domestic and overseas building automatic doors and domestic platform doors.

O.P. : Profits are expected to increase as the PMI*¹ cost in a North American subsidiary will come to an end, although strategic investment is planning.

*1 PMI(Post Merger Integration)

Manufacturing Solutions Segment (MFR)

- Sales and profit are expected to increase due to robust both in domestic and overseas demand from the food industry.

Result and Plan

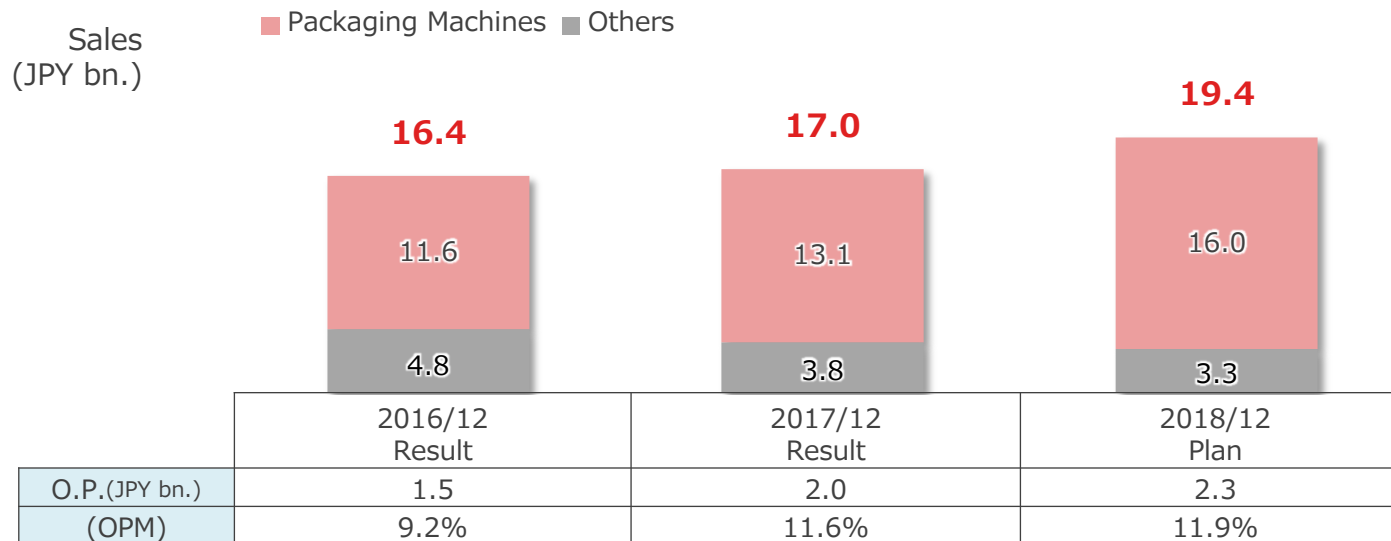

FY2017/12 Result vs. FY2018/12 Plan

Packaging Machines : Sales are expected to increase due to robust demand from the food industry on the back of labor-saving and automation need as well as sales expansion in Southeast Asia.

O.P. : Expansion of profits by increasing sales.

CAPEX, R&D and Depreciation

- Capital expenditure was implemented centering on precision reduction gears and aircraft equipment for future growth.

Precision reduction gears : Enhancing the production capacity of plants in Japan and China.

Aircraft equipment : Capacity expansion built for new programs.

(JPY bn.)	2016/12 Result	2017/12 Result	2018/12 Plan
CAPEX	14.5	15.5	30.4
R&D	7.4	8.7	10.2
Depreciation	7.4	9.0	11.2

1. Annual Consolidated Results for FY2017/12

2. Forecast for FY2018/12

3. Progress in Mid-Term Management Plan



Progress in Mid-Term Management Plan ~ROE15%~

■ Progress in Mid-Term Management Plan

- The first fiscal year of the Medium-term Management Plan recorded performance exceeding our expectation.
- A revision to the Medium-term Management Plan will be implemented by the end of the current fiscal year.

■ ROE15%

- ROE has been advancing steadily towards the target of 15% in FY 2020.

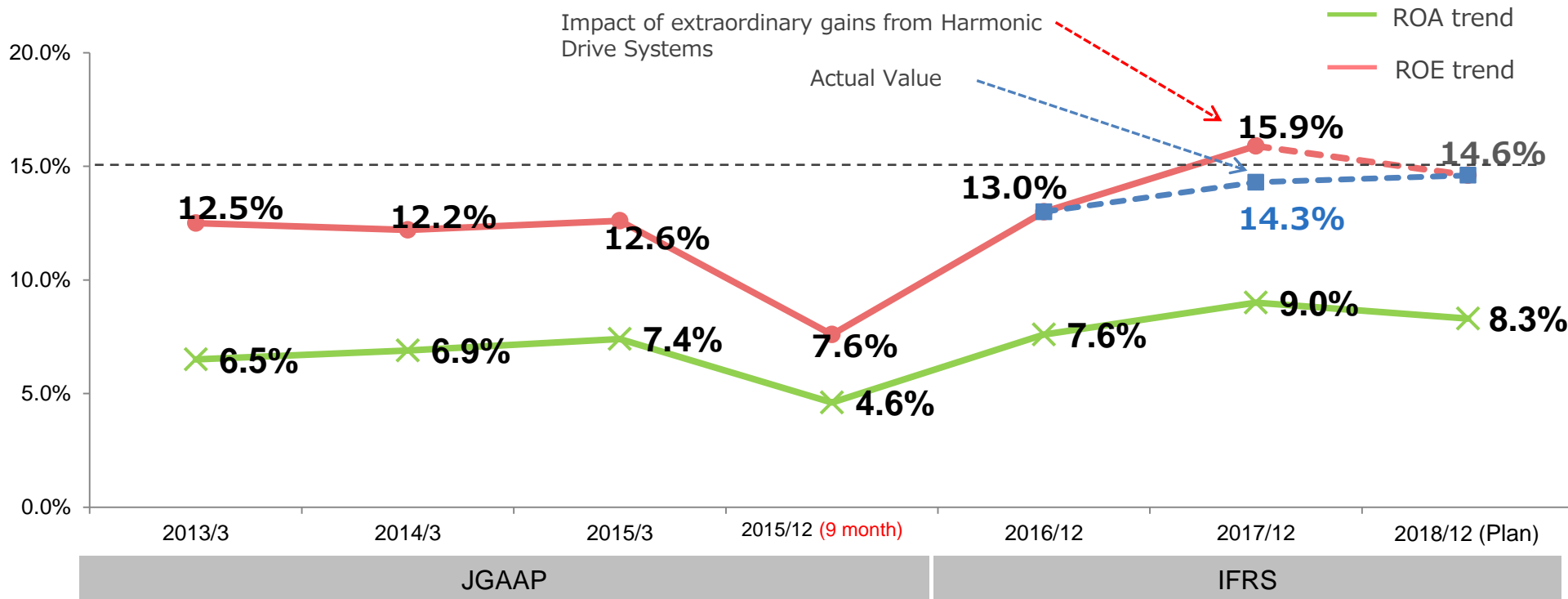

Progress in Mid-Term Management Plan

~Consolidated payout ratio 35% or higher~

■ Consolidated payout ratio 35% or higher

■ The pay-out ratio in FY 2017 was 35.3%.

(The pay-out ratio will be maintained at a level of 35.0% or higher in FY 2018 and thereafter.)

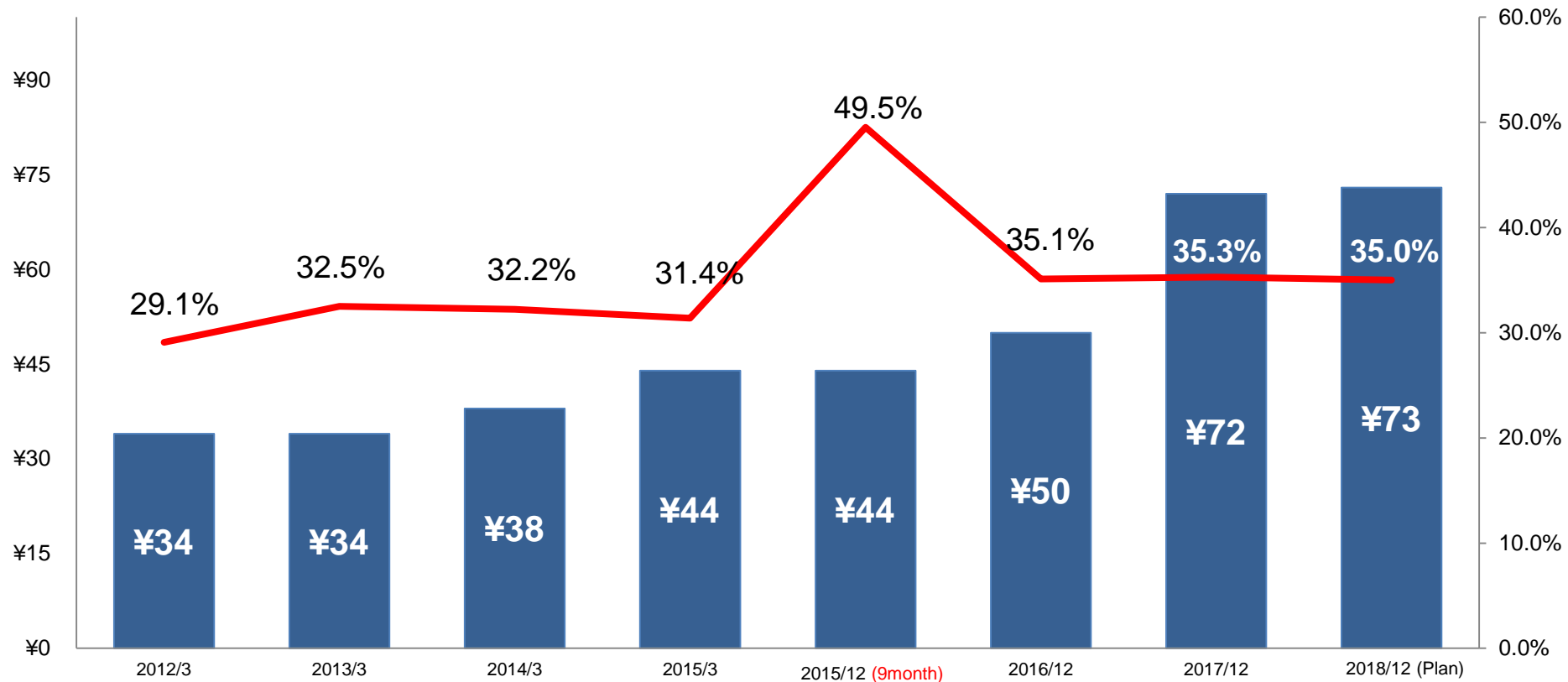

Progress in Mid-Term Management Plan

~Focus on solving ESG issues~

■ Focus on solving ESG issues

■ Received the 2016 Boeing Supplier of the Year (Award in the environmental category)

■ The Company's carbon dioxide reduction target was approved by the Science Based Targets (SBT) Initiative

(compared with FY 2015)	2030	2050
Reduction of CO ₂ emissions	-30%	-80%

■ Proactive investment for Environment-related investments

■ Trend of Environment-related investments

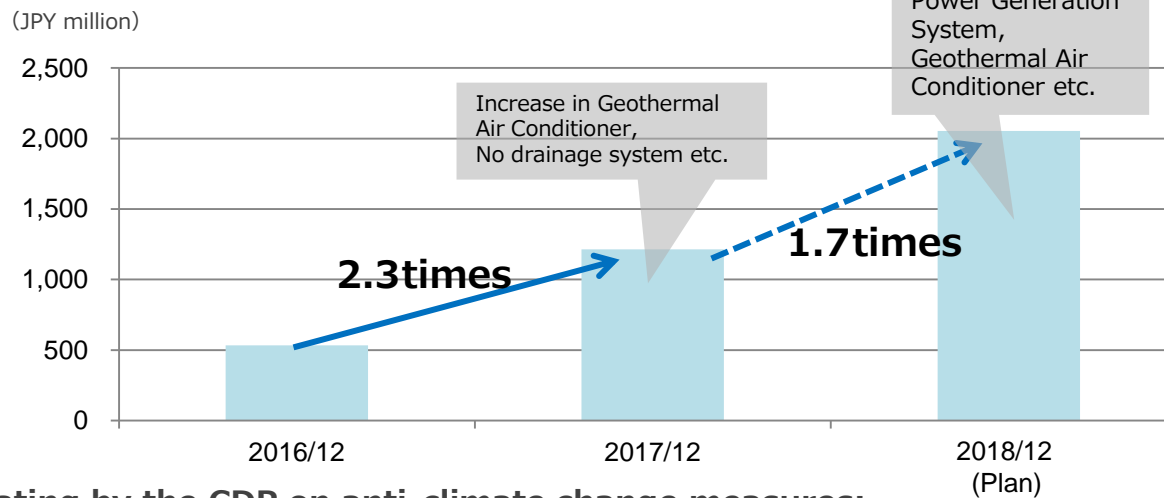

■ Rating by the CDP on anti-climate change measures:

Rated item	Result
Climate change	A
Water resource management	A ⁻

■ Named to 「The Supplier Climate A List 2018」 (Best evaluation of supplier dealing with climate change)

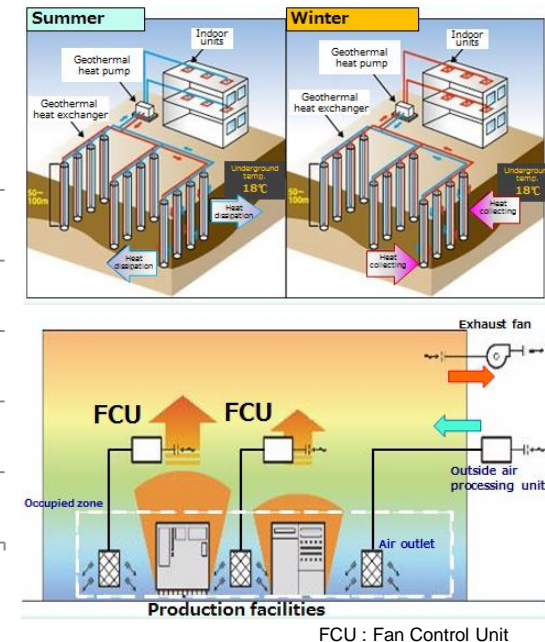

Appendix

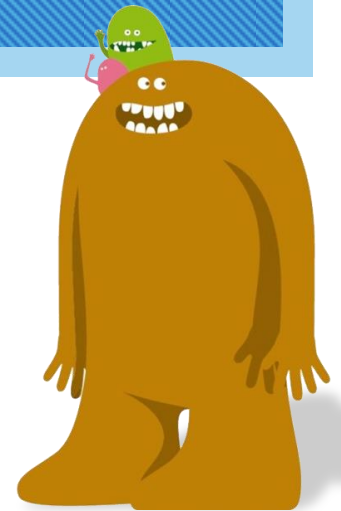

Basic Policy of the New Medium-term Management Plan

Basic Policy

Move forward! Challenge the future!
~ Create "New Value 2020" ~

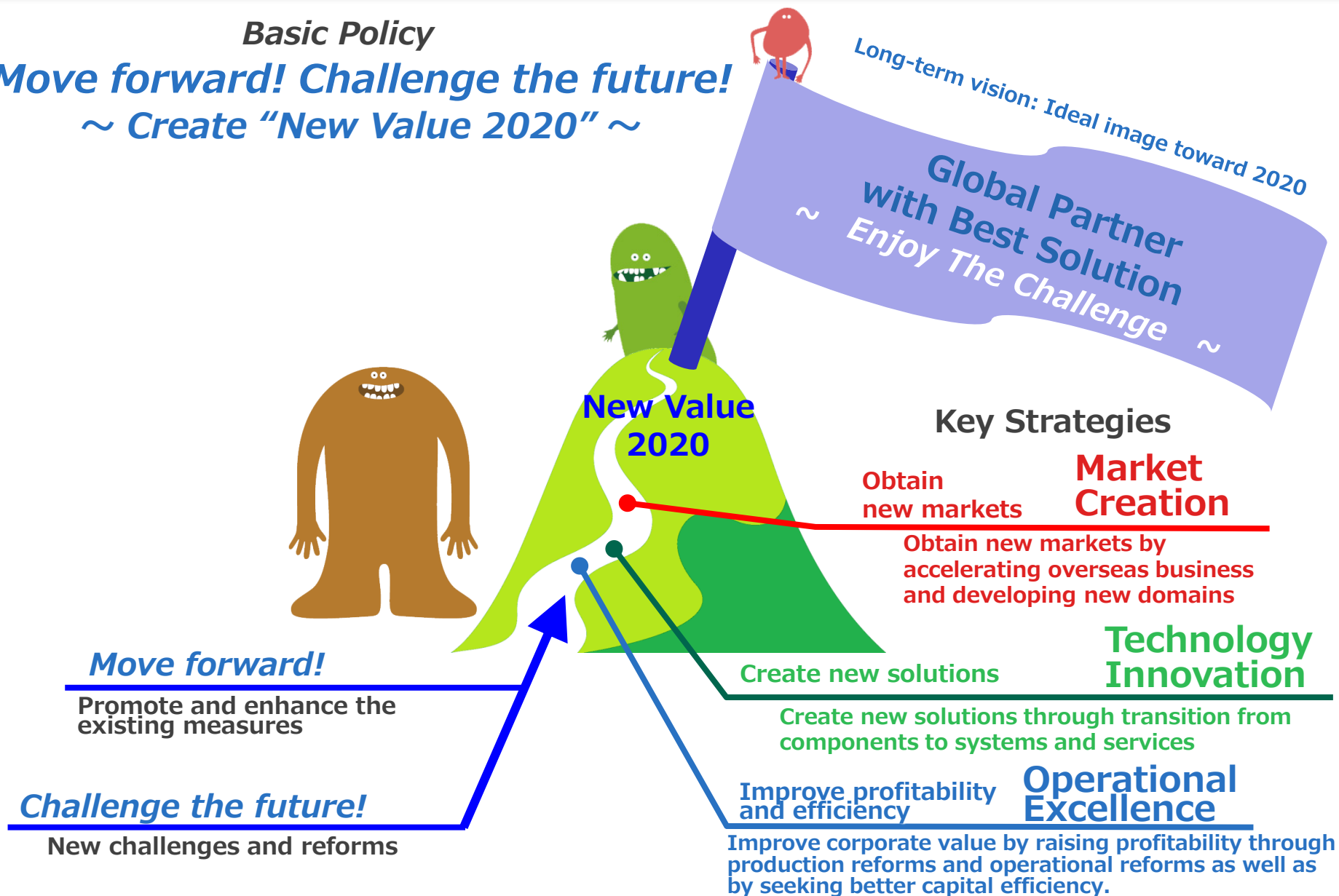

Effort to Mid-Term Management Plan in 2017

■ Market Creation . . . Obtain new markets by accelerating overseas business and developing new domains

- A European management company was established to reinforce the operation base with overall management of entry into European markets and our existing businesses in Europe.
- In the railroad vehicle equipment business, the acquisition of certifications is being sought aiming at entry into the European market.
- In the railroad vehicle equipment business, businesses for the Chinese subway project were expanded.
- An after-sales-service business base for Southeast Asia was established in Thailand.
- The import, sale and after-sales-service business in India was commenced by a local subsidiary.

■ Technology Innovation . . . Create new solutions through transition from components to systems and services.

- OVALO GmbH of Germany was acquired in order to obtain technologies related to systematization and mechatronization.
- A unified research and development management system was set up by establishing “Nabtesco R&D Center.”
- In the hydraulic equipment business, a new product jointly developed with Hyst Corporation, which was acquired in 2015, was launched.

■ Operational Excellence . . . Improve corporate value by raising profitability through production reforms and operational reforms as well as by seeking better capital efficiency.

- Activities for improvement of productivity (+10% by 2020) by highly automating production and introducing robots were commenced.
- An automated tool was introduced for miscellaneous operations.
- The commencement date of the new management system was unified with that of fiscal year to further clarify the operational accountability.

ROE : 15%

**Consolidated payout ratio:
35% or over**

**Focus on solving
ESG issues**

Breakdown in CAPEX

By Segment

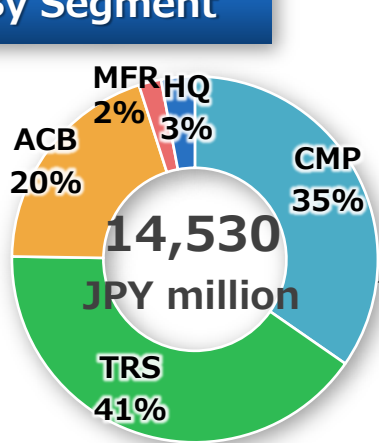

- Precision reduction gears:
 - Installation of new facilities in the new China plant

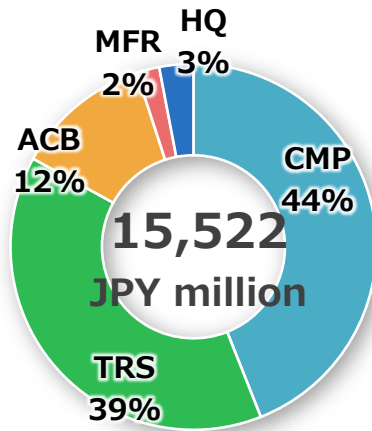

- Environment-related investments
- R&D-related investments

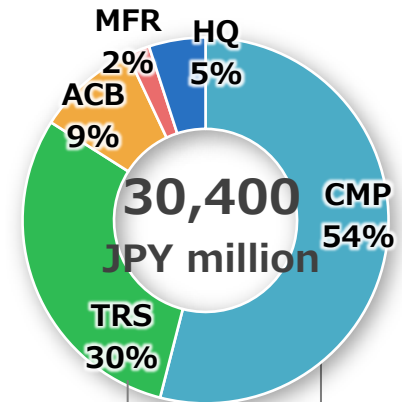

- Precision reduction gears:
 - Increase production capacity in Japan and China
- Aircraft equipment:
 - Capacity expansion at Gifu Plant

By Usage

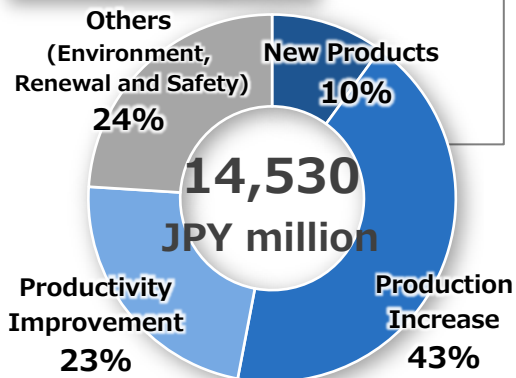

2016/12 Result

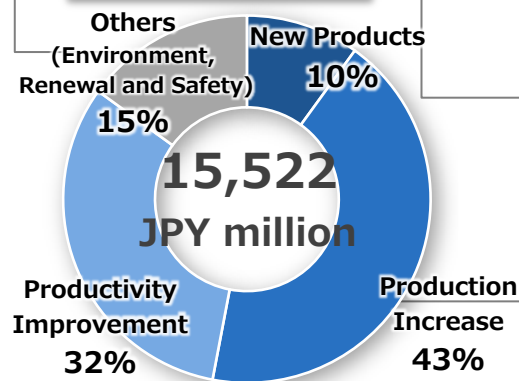

2017/12 Result

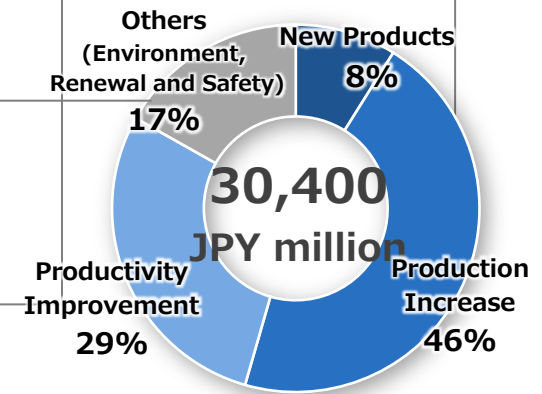

2018/12 Plan

Result and Forecast for Sales and Operating Profit by Business Segment

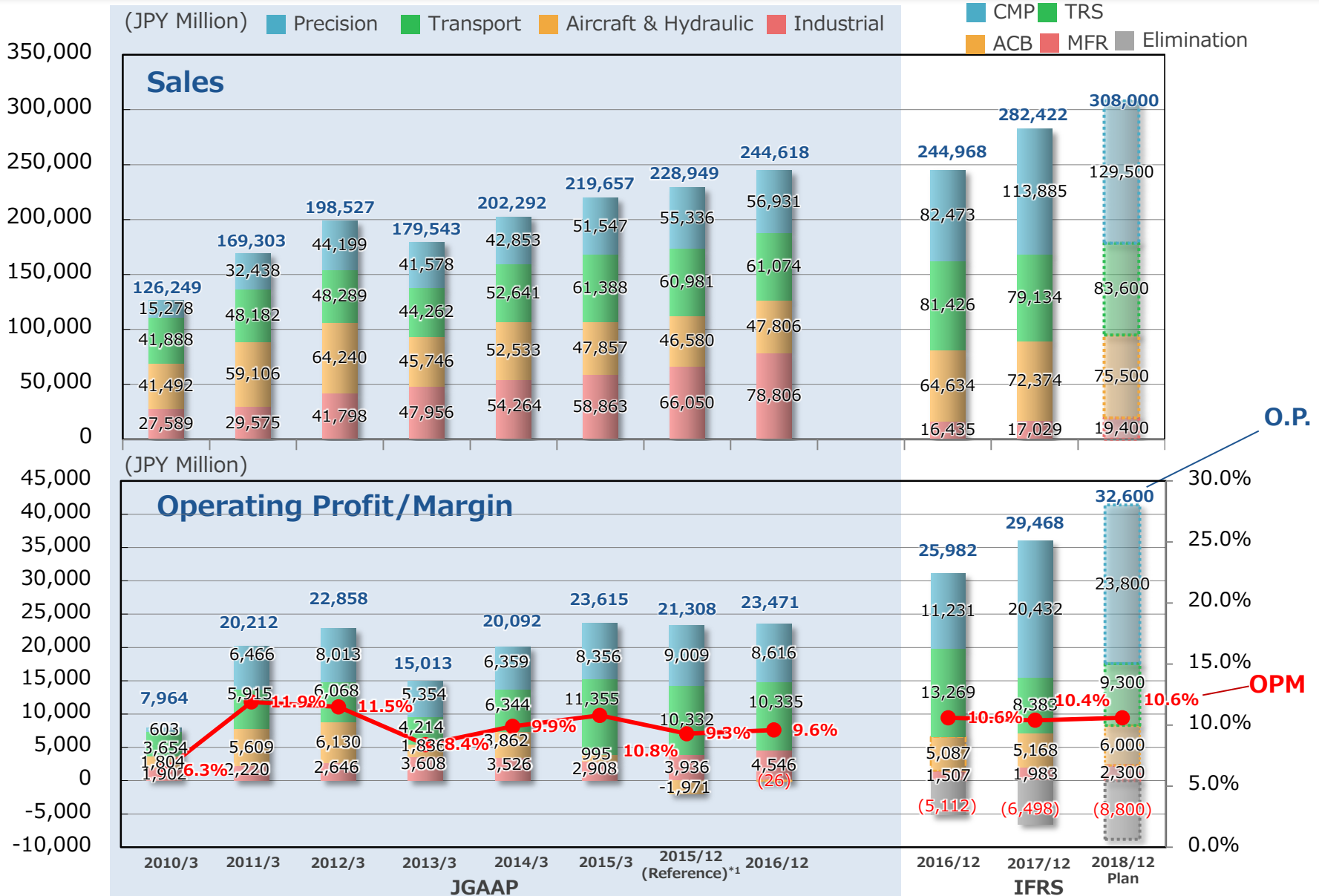

*1 Please note that estimates for 2015/12 (reference) were calculated for the period of 12 M to make comparisons with the plan for 2016/12 under the same conditions.

Full-year Segment Sales and O.P.

(JPY million) Segment	Term	2016/12 Result	2017/12 Jul.2017 plan	2017/12 Result	2018/12 Plan	2020/12 Mid-term reference
Component Solutions (CMP)	Sales	82,473	103,600	113,885	129,500	118,400
	O.P. (OPM)	11,231 (13.6%)	18,200 (17.6%)	20,432 (17.9%)	23,800 (18.4%)	22,200 (18.8%)
Transport Solutions (TRS)	Sales	81,426	80,600	79,134	83,600	104,400
	O.P. (OPM)	13,269 (16.3%)	10,200 (12.7%)	8,383 (10.6%)	9,300 (11.1%)	17,200 (16.5%)
Accessibility Solutions (ACB)	Sales	64,634	71,100	72,374	75,500	79,200
	O.P. (OPM)	5,087 (7.9%)	5,800 (8.2%)	5,168 (7.1%)	6,000 (7.9%)	7,900 (10.0%)
Manufacturing Solutions (MFR)	Sales	16,435	17,700	17,029	19,400	27,700
	O.P. (OPM)	1,507 (9.2%)	1,600 (9.0%)	1,983 (11.6%)	2,300 (11.9%)	3,200 (11.6%)
Other Profit or Loss		-5,112	-7,400	-6,498	-8,800	-8,500
Total	Sales	244,968	273,000	282,422	308,000	330,000
	O.P. (OPM)	25,982 (10.6%)	28,400 (10.4%)	29,468 (10.4%)	32,600 (10.6%)	42,000

Sales by Business (IFRS)

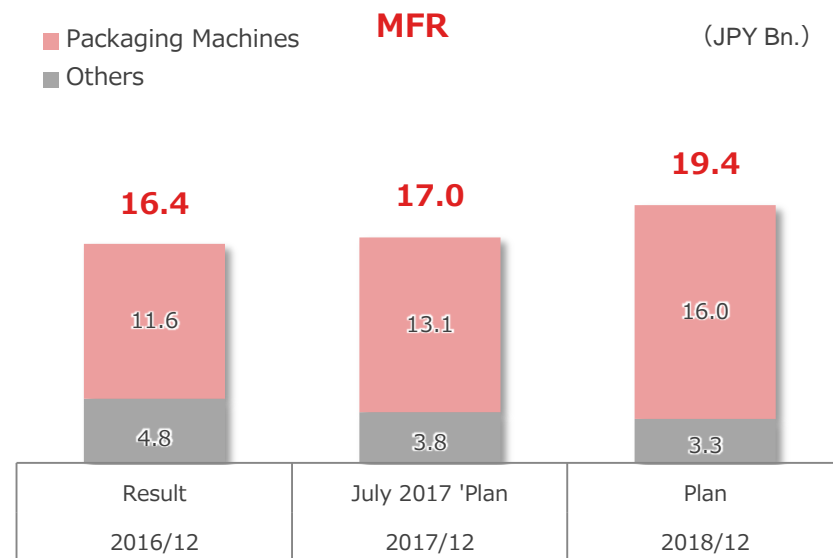
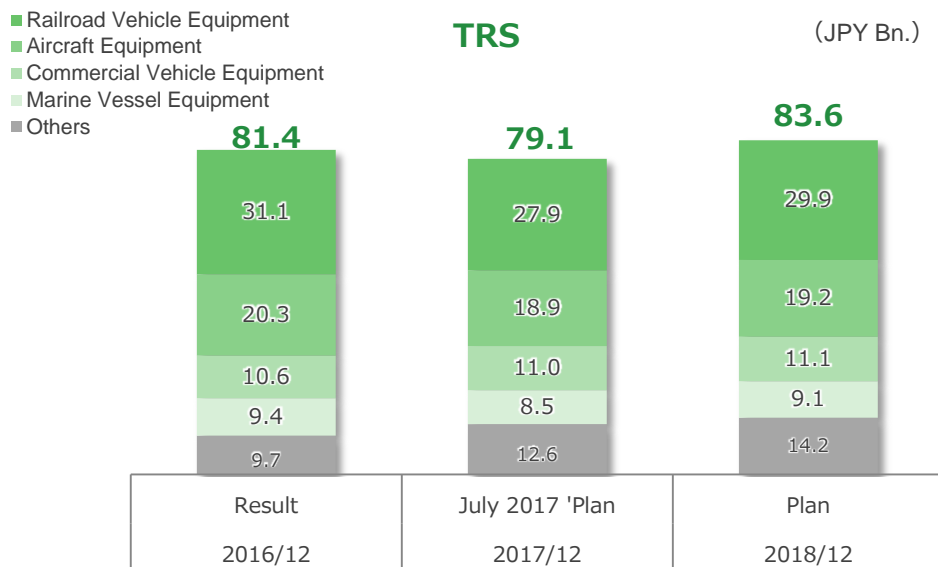
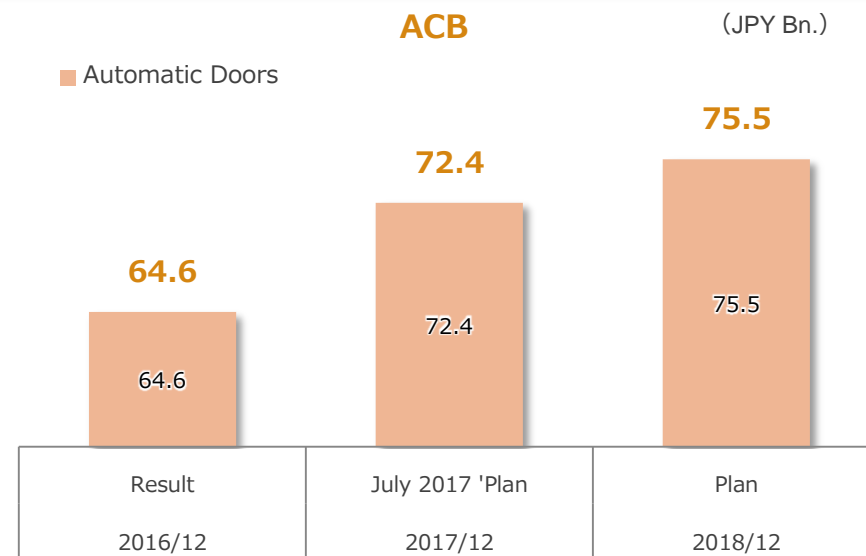
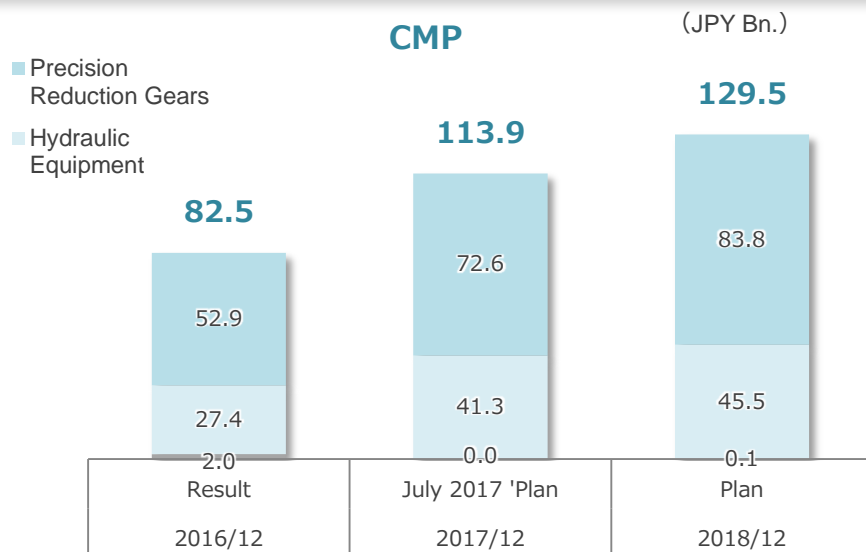

Sales by Business

Precision Equipment Segment

(JPY billion)

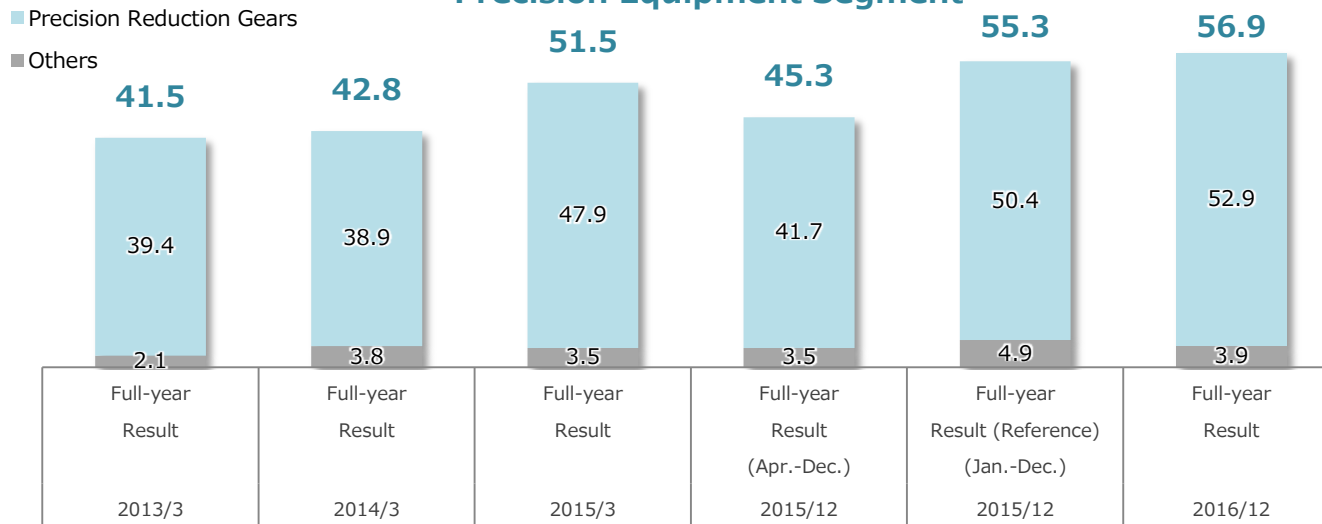

Transport Equipment Segment

(JPY billion)

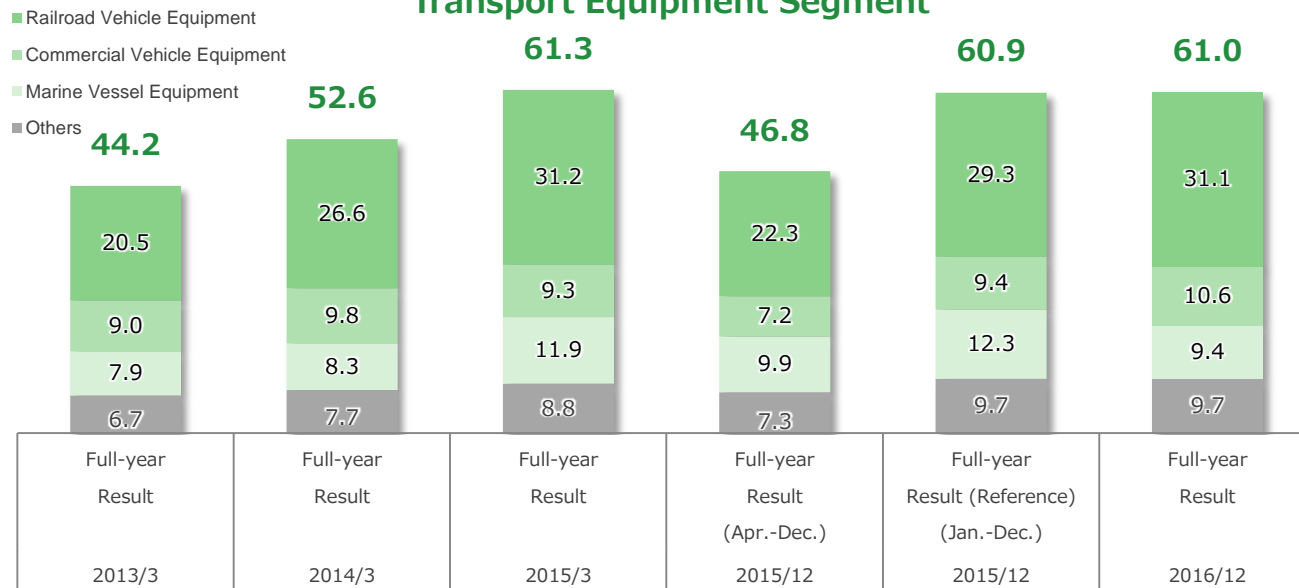

Sales by Business

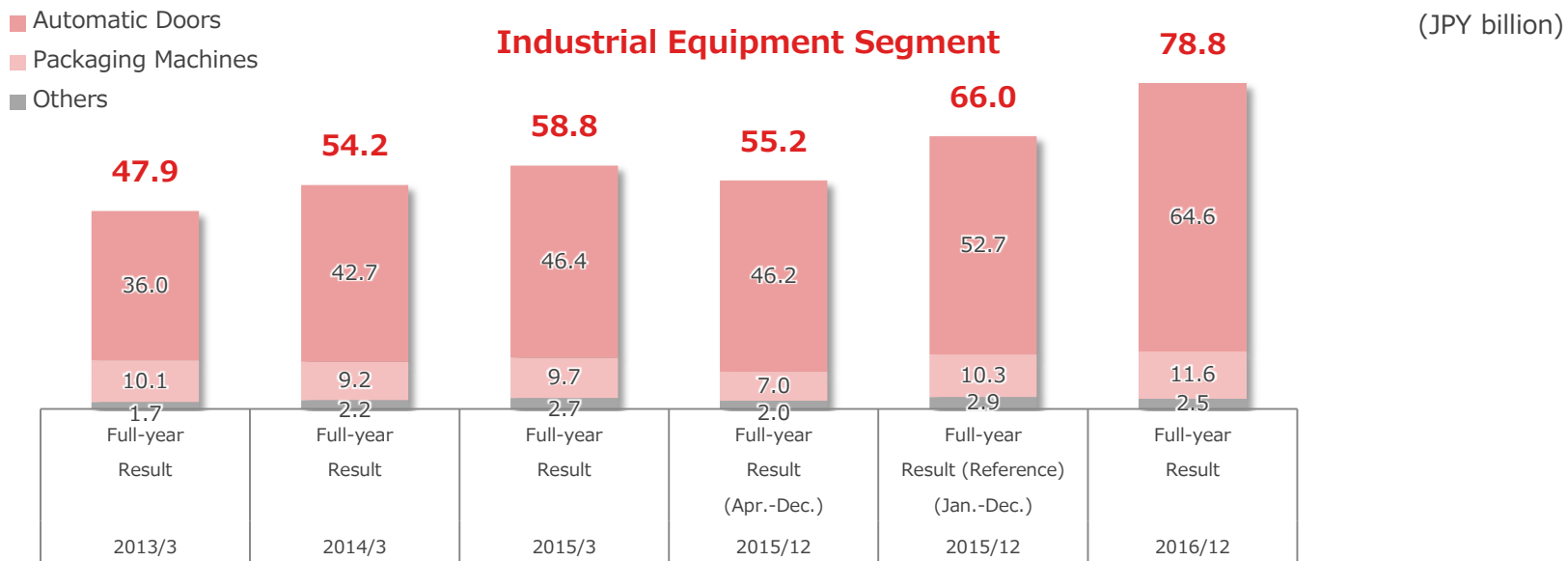
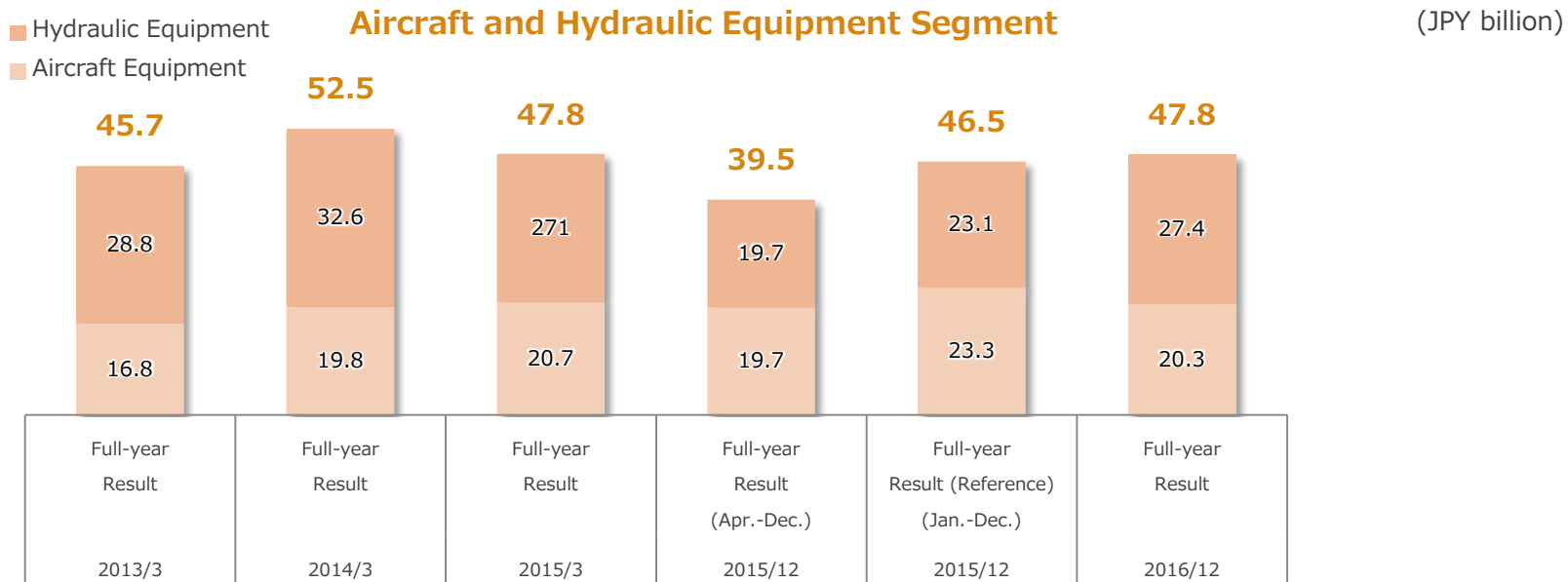

Precision reduction gears : Production capacity (ordinary)

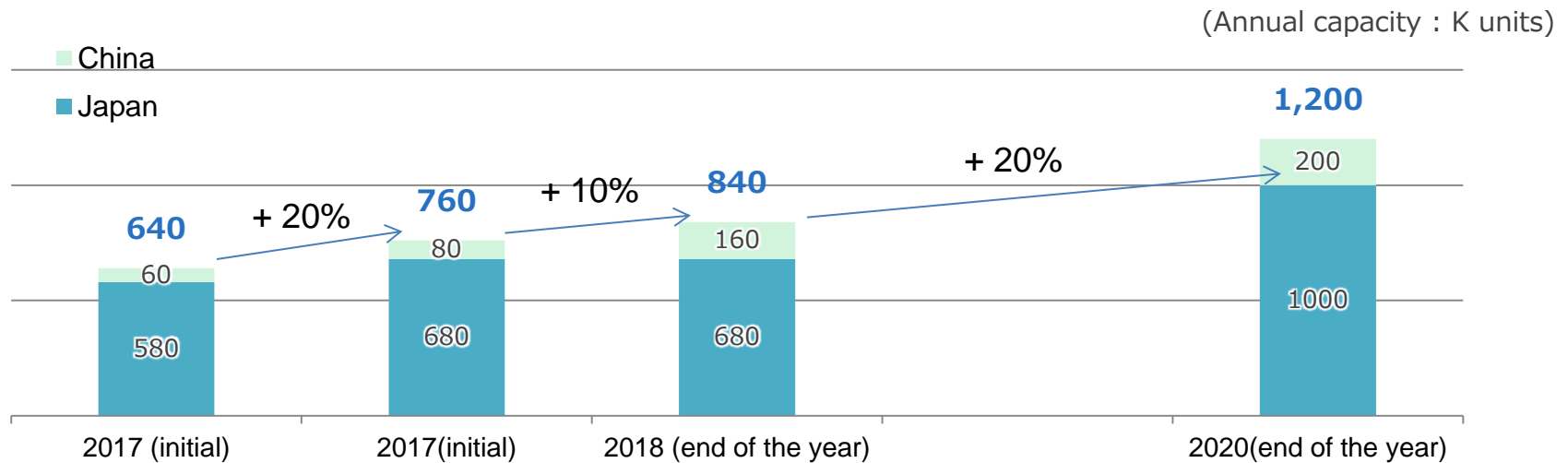

- Production capacity is going to be expanded to 1.2 million units per year adding up Japan plant and China plant by 2020.

Overview of Market Conditions in 2017 and 2018

CMP : Precision Reduction Gears

According to the Japan Robot Association, sales of robots during the period of July-September 2017 amounted to 189.0 billion yen, **a year-on-year increase of 34%. As to the full-year forecast for 2018, sales are expected to reach 1 trillion yen, a 10% increase from the previous year.** Mr. Inaba, Chairman of the association, concurrently serving as the Chairman of FANUC CORPORATION, emphasizes that the expansion of demand for robots will continue for more than five years, and that sales of 2 trillion yen will be just a milestone.

(28th Jan. 2018. Nikkei Veritas)

CMP : Hydraulic Equipment

The Japan Construction Equipment Manufacturers Association announced on January 31 that the shipment value of construction machinery in 2017 (total amount including supplemental parts) reached 2,551.3 billion yen, **a 19.1% increase year on year, representing the first increase in three years.** Overseas demand including North America and Asia contributed to the overall growth driven by the increase in demand for construction machinery on the back of infrastructure construction and housing, while last-minute purchase also expanded prior to the enforcement of stricter emissions control in Japan. Shipments have increased to a wide range of destinations outside Japan spurred by world-wide economic growth. **While a large volume of construction machinery is produced locally in China, the Chinese market turned upward since the end of 2016, and demand remained robust and steady throughout the year of 2017.** “Sales of construction machinery have maintained high growth in China,” said Mr. Yasuhiro Inagaki, Senior Executive Officer of Komatsu Ltd., in a telephone interview on January 31.

(1st, Feb. 2018 The Nikkei)

Mr. Tetsuo Katsurayama, Executive Officer and Director of Hitachi Construction Machinery Co., Ltd. was quoted as saying that in the next fiscal year the momentum of Chinese demand growth will continue up to June.

(31st, Jan. 2018 The Nikkei)

TRS : Marine Vessel Equipment

Shipping firms consider the Chinese environmental regulation as a favorable drive. Chinese steel makers increased the use of Brazilian and Australian iron ore of higher quality, **resulting in the brisk movement of freight. The average Baltic Dry Index, a freight index of bulk resource carriers, for 2017 recorded its highest level in four years.**

(4th Feb. 2018. Nikkei Veritas)

Main Products: Component Solutions Segment (CMP)

Precision Reduction Gears

■ Joints of Industrial Robots



No.1
Approx. **60%**
world market share

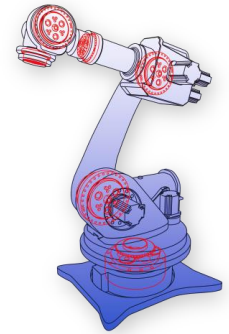

Hydraulic Equipment

■ Traveling Unit for Hydraulic Excavators



Approx. **25%**
world market share

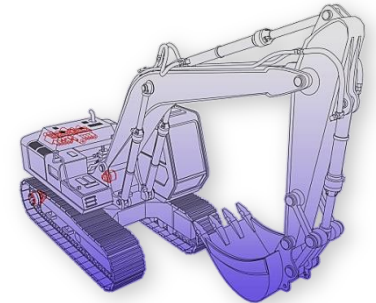

■ Drive Units for Wind Turbines

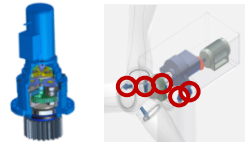

Main Customers

■ Precision Reduction Gears

Industrial Robots: Fanuc, Yaskawa Electric, KHI, KUKA Roboter (Germany), ABB Robotics (Sweden)

Machine Tools: Yamazaki Mazak, Okuma, DMG Mori Seiki

■ Hydraulic Equipment

Traveling Units: Japan: Komatsu, Kobelco Construction Machinery, Kubota, Sumitomo Construction Machinery

China: Sany, Zoomlion, XCMG, Liu Gong

Drive Units for Wind Turbines: MHI, Hitachi, Ltd., Others

Main Products: Transport Solutions Segment (TRS)

Railroad Vehicle Equipment

■ Brake Systems

Others



No.1

Approx. **50%** Domestic Market Share

■ Door Operating Systems

Others



No.1

Approx. **70%** Domestic Market Share

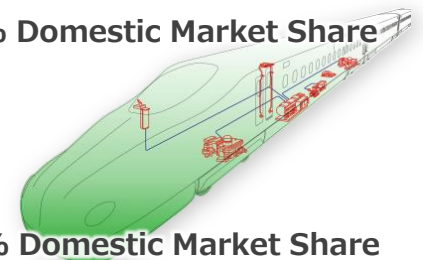

Aircraft Equipment

■ Flight Control Actuation Systems (FCA)

- One of the four major world players for FCA systems (major FCA supplier to Boeing Company)
- Expanding business into engine accessories and power supply systems

No.1



Approx. **100%** market share for domestically-produced aircrafts

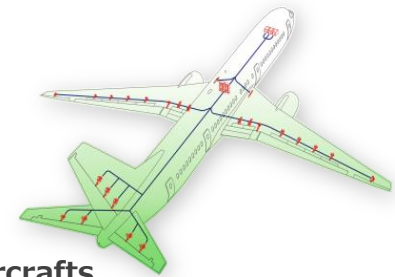

Main Customers

■ Railroad Vehicle Equipment

JR Companies, Private railway companies, KHI, Bullet train and subway projects in China

■ Aircraft Equipment

Boeing, KHI, MHI, IHI, Japanese Ministry of Defense, Airlines

Main Products: Transport Solutions Segment (TRS)

Commercial Vehicle Equipment

■ Wedge Chambers

Others

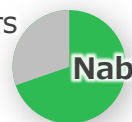

Nabtesco 70%

No.1

Approx. **70%** Domestic Market Share

■ Air Dryers

Others

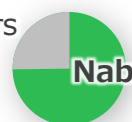

Nabtesco 75%

No.1

Approx. **75%** Domestic Market Share



Marine Vessel Equipment

■ 2ST Main Engine Control Systems

Others

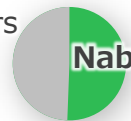

Nabtesco 50%

No.1

Approx. **50%** Domestic Market Share
(Approx. 40% World Market Share)



Main Customers

■ Commercial Vehicle Equipment

Hino, Isuzu, Mitsubishi Fuso Truck & Bus, UD Trucks

■ Marine Vessel Equipment

KHI, Mitsui Engineering & Shipbuilding, MHI, Hitachi Zosen, Hyundai Heavy Industries (Korea), Doosan Engine (Korea), Hudong Heavy Machinery (China), MAN Diesel (Denmark)

Main Products: Accessibility Solution Segment (ACB)

Automatic Doors

Automatic Doors



Platform Screen Doors



Main Customers

Automatic Doors

Automatic Doors for buildings: Major general contractors, sash manufacturers, hospitals, banks, public institutions, etc.

Platform Doors : Subway projects in France and China, others

Main Products: Manufacturing Solutions Segment (MFR)

Packaging Machines

Packaging Machines for Retort Pouch Foods

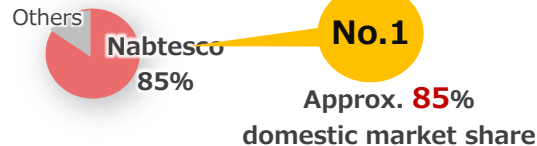

Main Customers

Packaging Machines

Mitsui Sugar, Ajinomoto, Marudai Food Co., Ltd., ARIAKE Japan, KENKO Mayonnaise, P&G, Kao, Lion, beverage companies in North America, food companies in China

Consolidated Cash Flow

(JPY million)

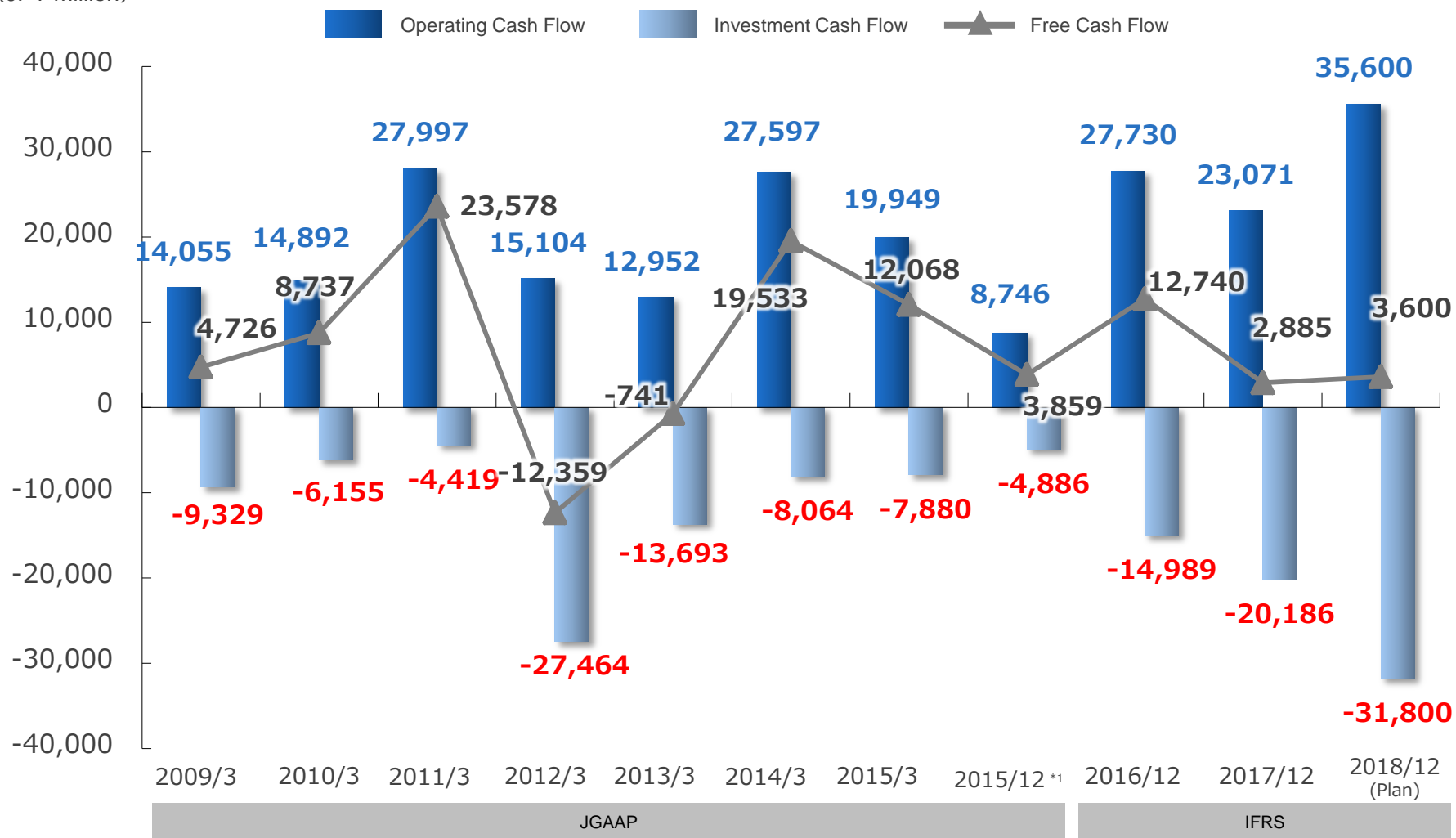

*1 Please note that the estimates for FY2015/12 (Reference) were calculated for the period of 12 months to make comparisons with the result for FY2016/12 under the same conditions.

Nabtesco

moving it. stopping it.

